

## Current clamps for AC current

B100 series



### B SERIES

The only model in the B series, the B102 is designed to measure earth leakage currents caused by insulation faults.

It enables the fault to be located and diagnosed before failure occurs thus avoiding installation shutdown.

It is designed specifically for locating low-current faults on high-current circuits.

The B102 measures differential or leakage current from 500  $\mu$ A upwards and may be used to measure currents up to 400 A in continuous use (400 A max.).

The B102 has two measurement ranges, 1 mV/mA or 1 mV/A.

As a leakage current detector, the B102 can be used on single or multiphase systems whether the currents are in or out of phase, balanced or unbalanced.

The B02 may be used simply as a high-precision clamp-on current probe.

With its 115 mm jaw opening and dynamic measurement range from 500  $\mu$ A to 400 A, the B102 is a versatile instrument, highly useful in the analysis of unbalanced circuits, leakage currents and earth loop currents.

When operated in conjunction with an artificial neutral, the B102 can also be used to measure fault currents on 3-phase circuits with no neutral.

(1) AN1 artificial neutral box (see chapter 13)

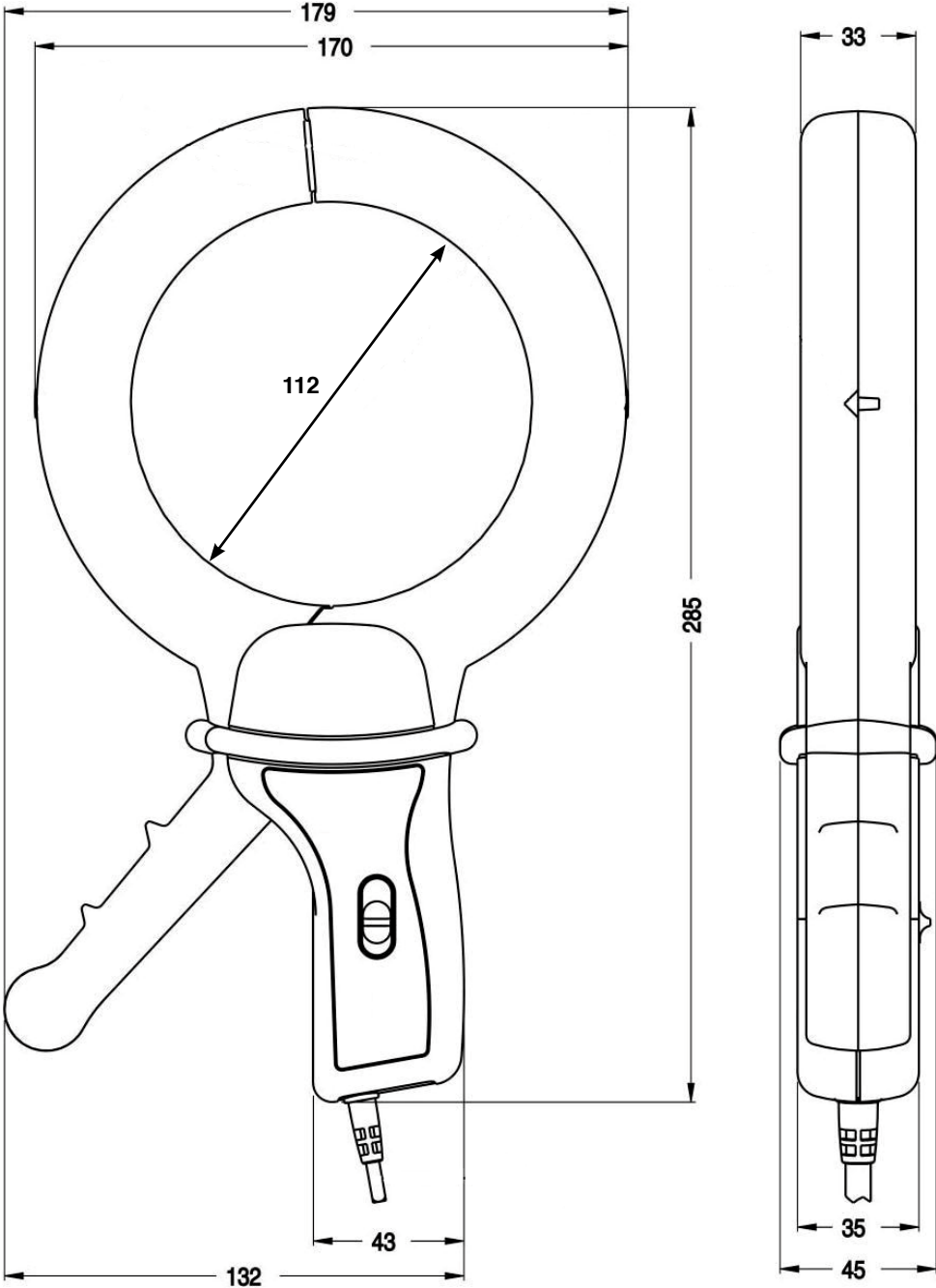

# Current clamp for AC current

## Model B102 (clamp for leakage currents)

B100 series

Current	4 AAC	400 AAC
Output	1 mV/mA	1 mV/A

### DESCRIPTION

The B102 clamp measures leakage currents or residual currents as low as 500 µA and can be used with multimeters equipped with a calibre in mV AC. The B102 clamp measures the currents flowing in earth loops as well as leakage currents. It can be used on live installations to detect insulation faults on the earth circuits of single and three-phase networks. For three-wire three-phase systems, use the artificial neutral box.

### ELECTRICAL SPECIFICATIONS

- **Current range:**  
0.5 mA AC .. 4 A AC  
0.5 A AC .. 400 A AC
- **Output signal:**  
1 mV AC / mA AC (4 V for 4 A)  
1 mV AC / A AC (0.4 V for 400 A)
- **Accuracy and phase shift (1):**

Calibre	4 A		
Primary current	0.5 mA .. 10 mA	10 mA .. 100 mA	100 mA .. 4 A
Accuracy in % of output signal	≤ 3% + 1 mV	≤ 0.5% + 0.5 mV	≤ 0.5% + 0.5 mV
Phase shift	not specified	≤ 15°	≤ 10°

Calibre	400 A		
Primary current	0.5 mA .. 10 mA	10 A .. 200 A	200 A .. 400 A
Accuracy in % of output signal	≤ 0.5% + 0.5 mV	≤ 0.35% + 0.5 mV	≤ 0.35% + 0.5 mV
Phase shift	not specified	≤ 1°	≤ 0.7°

- **Bandwidth:**  
30 kHz .. 1 kHz (depending on current value)
- **Maximum currents:**  
400 A AC continuous for a frequency ≤ 1 kHz  
Peak current < 1,000 A
- **Load impedance:**  
≥ 10 MΩ / 100 pF
- **Max. voltage output:**  
Electronic protection circuit limiting the voltage to 6 V peak max.
- **Influence of temperature:**  
Measurement: ≤ 100 ppm/K or 0.1 % of output signal per 10 °K
- **Influence of adjacent conductor:**  
0.4 mA/A typical at 50 Hz
- **Influence of an external field:**  
for 400 A calibre/m at 50 Hz
  - 4 A calibre: ≤ 60 mA
  - 400 A calibre: ≤ 0.1 A
- **Influence of conductor position in jaws:**  
≤ 0.1 % of the reading at 50/60 Hz (non-residual current)  
≤ 0.2 % of the reading at 50/60 Hz (residual current)

- **Influence of DC current superimposed on rated current AC:**  
for a current DC from 1 A
  - 4 A calibre: ≤ 1 mA
  - 400 A calibre: ≤ 0.1 A
- **Influence of frequency:**
  - 4 A calibre: ≤ 2 %
  - 400 A calibre: ≤ 0.5 % from 30 Hz to 1 kHz (limited to 100 A for 1 kHz)
- **Influence of the measurement instrument's input impedance (Z<sub>e</sub>):**
  - 4 A calibre: E% = [Z<sub>e</sub>/(Z<sub>e</sub> + 4.8) - 1] \* 100
  - 400 A calibre: E% = [Z<sub>e</sub>/(Z<sub>e</sub> + 0.0048) - 1] \* 100

### MECHANICAL SPECIFICATIONS

- **Operating temperature:**  
-10 °C to +55 °C
- **Storage temperature:**  
-40 °C to +70 °C
- **Max. jaw insertion capacity:**  
Cables: Ø 112 mm  
Busbars: 1 busbar 20 x 50 mm
- **Casing protection rating:**  
IP40 with clamp closed (NF EN 60529 Ed. 95)  
IP30 with jaws open

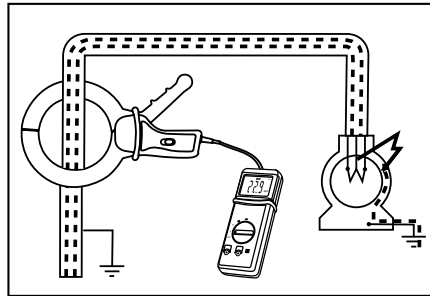

- **Relative humidity for operation:**  
0 to 85 % RH with a linear decrease above 35 °C
- **Operating altitude:**  
0 to 2,000 m
- **Drop test:**  
1 m (NF EN 61010-2-032)
- **Self-extinguishing capability:**  
Casing: V0 according to UL94  
Jaws: V2 according to UL94
- **Dimensions:**  
285 x 175 x 43 mm
- **Weight:**  
1.3 kg approx.
- **Colours:**  
Casing: dark grey  
Jaws: red
- **Output:**  
Cable with double insulation, length 1.5 m, terminated by 2 insulated elbowed male Ø 4 mm banana plugs

### SAFETY SPECIFICATIONS

- **Electrical safety:**  
Instrument with double insulation or reinforced insulation between the primary, the secondary and the grippable part located under the guard as per EN 61010-1 Ed. 2: 2001, EN 61010-2-031 Ed. 2002 & EN 61010-2-032 Ed. 2003
  - 600 V category III, pollution degree 2
  - 300 V category IV, pollution degree 2
- **Electromagnetic compatibility:**  
CE-certified equipment compliant with standard EN 61326-1 (Ed. 97) + A1 (Ed. 98) + A2 (Ed. 01)
  - Emission: regulations for class B equipment (domestic use)
  - Immunity: regulations for equipment operated intermittently on industrial sites.

# Current clamp for AC current Model B102 (clamp for leakage currents)

**B100 series**

## CURVES AT 50 HZ

4 A calibre

400 A calibre

Linearity for AC

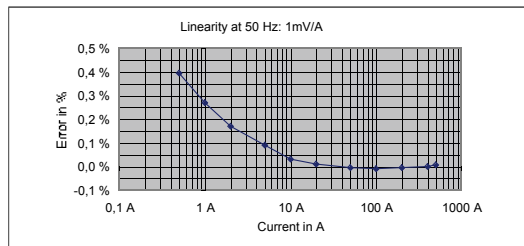
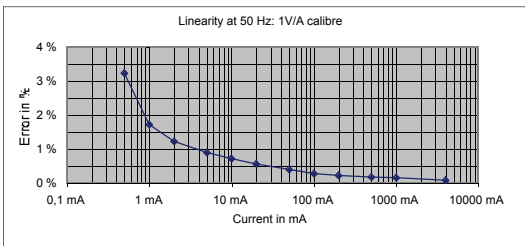

Phase shift

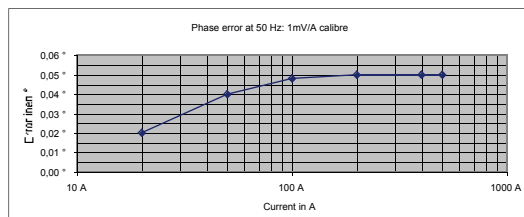
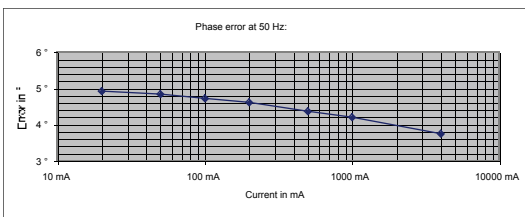

## FREQUENCY RESPONSE

4 A calibre

400 A calibre

Typical error on measurement

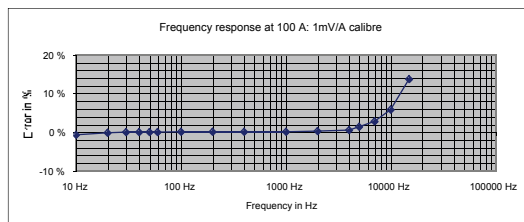
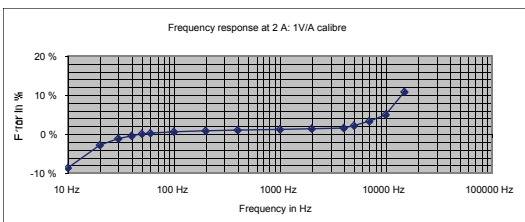

Typical phase shift

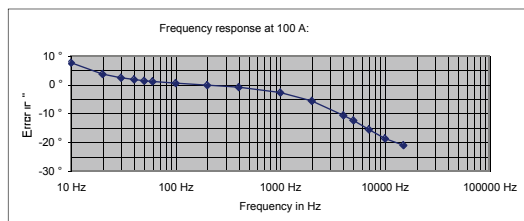
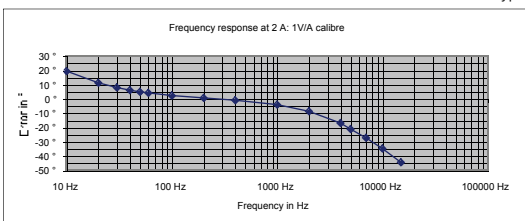

(1) Conditions of reference: 23°C ± 3°K, 20% to 75% RH, sinusoidal signal from frequency of 48 to 65 Hz, distortion factor < 1%, no DC components, external magnetic field < 40 A/m, no AC magnetic field, no external conductor with circulating current, conductor centred for measurement, load impedance ≥ 10 MΩ / ≤ 100 pF.

To order	Reference
AC current clamp model <b>B102</b> with operating manual	P01120083
Accessories: <b>AN1</b> artificial neutral box (see chapter 13) Hard case 320 x 255 x 75 mm	P01197201 P01298004